



Solar GEL Deep Cycle Battery

SPACEFLIGHT POWER Solar GEL Deep Cycle Battery is a hybrid GEL battery designed with deep cycle technology to provide extra-durable cycle performance for solar energy System. It offers more than 600 cycles at 80% DOD.

Applications

- Solar and wind power systems
- Communication systems
- Uninterruptible power supplies
- Alarm and security system

General Features

- 12 years designed floating life(25 °C)
- Non-spillable construction
- Sealed and maintenance-free
- Excellent recovery from deep discharge
- High density active materials plates
- Longer Life and low self-discharge

Standards

- Compliance with IEC, BS, JIS and EU standards.
- UL, CE Certified
- ISO45001,ISO9001 and ISO14001 certified production facilities

Specifications

Rated Voltage	12V	
Nominal Capacity	250Ah	(C ₁₀ , 10.8V)
Approx Weight	70.5kg±3%(155.43lbs)	
Terminal	F12	
Rated Capacity(25°C)	262 Ah	(20hr,13.1A,10.5V)
	250 Ah	(10hr,25A,10.8V)
	213 Ah	(5hr,43A,10.5V)
	159 Ah	(1hr,159A,9.6V)
Max.Discharge Current	2500A(5s)	
Max.Charge Current	62.5A	
Internal Resistance(25°C)	Approx 4mΩ	
Operating Temp.Range	Discharge	-20~60 °C(-4~140 °F)
	Charge	-10~50 °C(14~122 °F)
	Storage	-20~60 °C(-4~140 °F)
Nominal operating temperature	25±5°C	
Charge Voltage @25°C(77 °F)	Cycle Use	Initial Charging Current less than 62.5A. Voltage 14.4V~15.0V at 25°C(77°F)Temp. Coefficient -30mV/°C
	Standby Use	Initial Charging Current less than 62.5A. Voltage 13.5V~13.8V at 25°C(77°F)Temp. Coefficient -20mV/°C
Temperature effects on capacity	40 °C (104 °F)	103%
	25 °C (77 °F)	100%
	0 °C (32 °F)	86%
	-15 °C (5 °F)	65%
Self Discharge(25°C)	Capacity after 3 months storage	91%
	Capacity after 6 months storage	82%
	Capacity after 12 months storage	65%



Dimensions

unit:mm

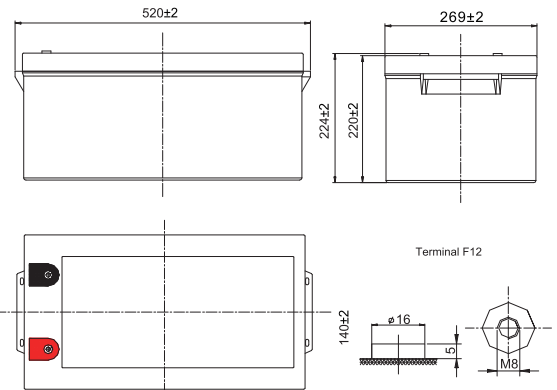

Length	520±2mm (20.5 inches)
Width	269±2mm(10.6inches)
Container Height	220±2mm (8.66 inches)
Total Height	224±2mm (8.82 inches)

Battery Construction

Component	Positive plate	Negative plate	Container	Safety valve	Terminal	Separator	Electrolyte
Raw material	Lead dioxide	Lead	ABS(UL94-HB) or FR(UL94-V0)	Rubber	Copper	AGM	SiO ₂ +H ₂ SO ₄

Constant Current Discharge (Amperes) at 25°C(77°F)

E.V/Time	5min	10min	15min	30min	60min	3h	5h	10h	20h
1.60V	/	577	401	265	159	69.0	44.5	25.5	13.3
1.65V	/	552	382	259	156	68.0	44.0	25.4	13.2
1.70V	/	527	363	251	153	67.0	43.5	25.3	13.2
1.75V	/	502	343	243	150	65.8	43.0	25.2	13.1
1.80V	/	473	318	234	145	64.3	42.3	25.0	13.0

Constant Power Discharge (Watts/cell) at 25°C(77°F)

E.V/Time	5min	10min	15min	30min	45min	60min	2h	3h	5h
1.60V	/	981	748	511	394	322	187	143	82.6
1.65V	/	966	733	508	392	320	186	142	84.3
1.70V	/	948	726	504	389	317	184	141	84.0
1.75V	/	913	718	501	387	314	183	140	83.7
1.80V	/	875	707	496	384	310	181	138	83.3

Note: The above characteristics data are average values obtained Within three charge/discharge cycles not the minimum.

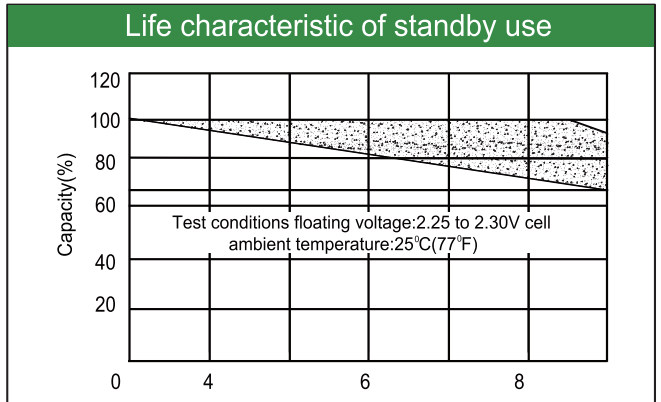
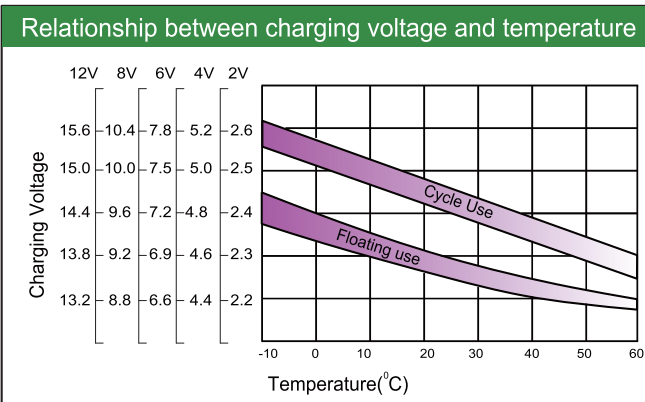
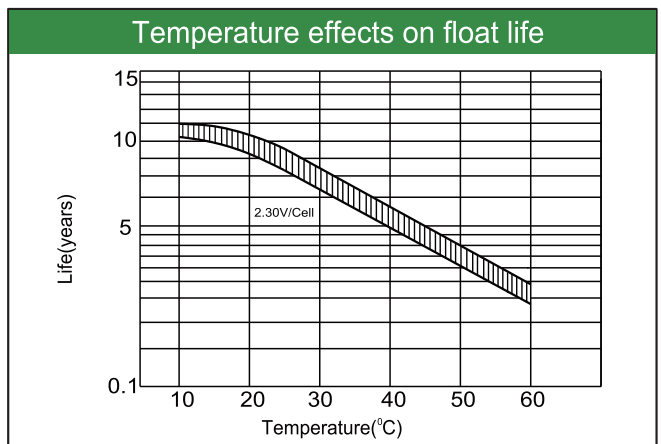
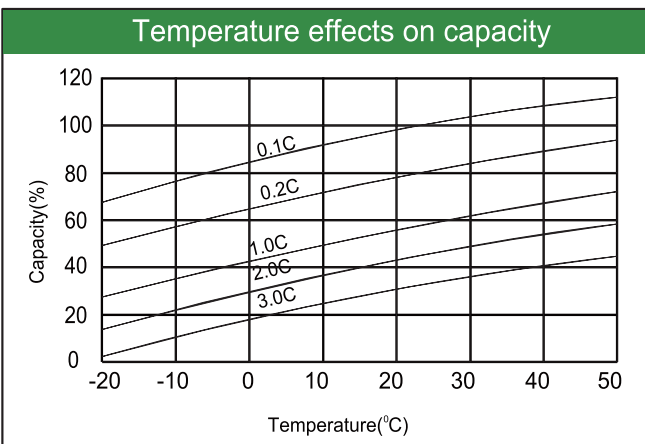
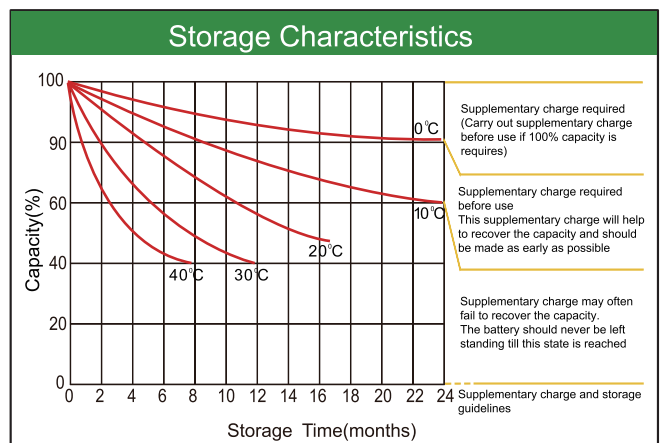
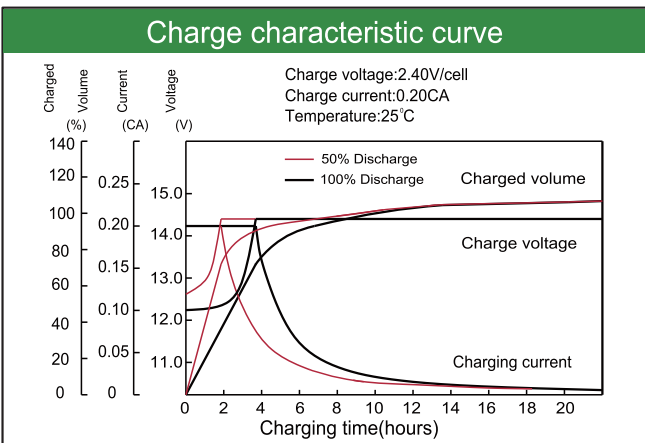
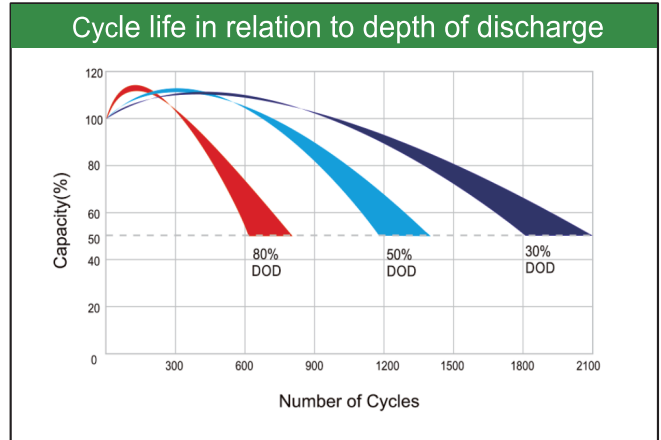
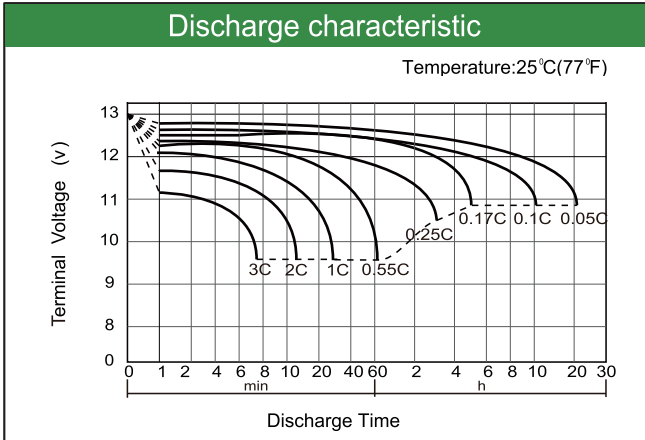

Factory Address: Fukang industrial park, LongNan, GanZhou JianXi.
 Office add: RM208-210, Building D, Tongju industrial Park, No.4, Longping West Road, Longgang District, Shenzhen.
 TEL: +86-755-28288189 sales@sfbattery.com www.sfbattery.com