



Solar GEL Deep Cycle Battery

SPACEFLIGHT POWER Solar GEL Deep Cycle Battery is a hybrid GEL battery designed with deep cycle technology to provide extra-durable cycle performance for solar energy System. It offers more than 600 cycles at 80% DOD.

Applications

- Solar and wind power systems
- Communication systems
- Uninterruptible power supplies
- Alarm and security system

General Features

- 12 years designed floating life(25 °C)
- Non-spillable construction
- Sealed and maintenance-free
- Excellent recovery from deep discharge
- High density active materials plates
- Longer Life and low self-discharge

Standards

- Compliance with IEC, BS, JIS and EU standards.
- UL, CE Certified
- ISO45001,ISO9001 and ISO14001 certified production facilities

Specifications

Rated Voltage	12V	
Nominal Capacity	65Ah	(C ₁₀ , 10.5V)
Approx Weight	20.5kg±3%(45.19lbs)	
Terminal	F11	
Rated Capacity(25°C)	68 Ah	(20hr,3.4A,10.5V)
	65 Ah	(10hr,6.5A,10.5V)
	55.5 Ah	(5hr,11.1A,10.5V)
	39.5 Ah	(1hr,39.5A,9.6V)
Max.Discharge Current	650A(5s)	
Max.Charge Current	16.3A	
Internal Resistance(25°C)	Approx 7mΩ	
Operating Temp.Range	Discharge	-20~60 °C(-4~140 °F)
	Charge	-10~50 °C(14~122 °F)
	Storage	-20~60 °C(-4~140 °F)
Nominal operating temperature	25±5 °C	
Charge Voltage @25°C(77 °F)	Cycle Use	Initial Charging Current less than 16.3A. Voltage 14.4V~15.0V at 25°C(77°F)Temp. Coefficient -30mV/°C
	Standby Use	Initial Charging Current less than 16.3A. Voltage 13.5V~13.8V at 25°C(77°F)Temp. Coefficient -20mV/°C
Temperature effects on capacity	40 °C (104 °F)	103%
	25 °C (77 °F)	100%
	0 °C (32 °F)	86%
	-15 °C (5 °F)	65%
Self Discharge(25°C)	Capacity after 3 months storage	91%
	Capacity after 6 months storage	82%
	Capacity after 12 months storage	65%



Dimensions unit:mm

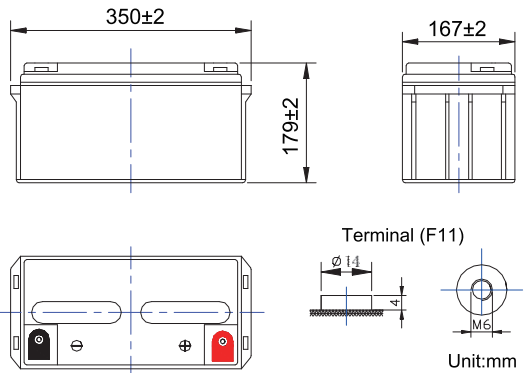

Length	350±2mm (13.78 inches)
Width	167±2mm (6.57 inches)
Container Height	179±2mm (7.05 inches)
Total Height	179±2mm (7.05 inches)

Battery Construction

Component	Positive plate	Negative plate	Container	Safety valve	Terminal	Separator	Electrolyte
Raw material	Lead dioxide	Lead	ABS(UL94-HB) or FR(UL94-V0)	Rubber	Copper	Fiberglass	Sulfuric acid

Constant Current Discharge (Amperes) at 25°C(77°F)

E.V/Time	5min	10min	15min	30min	60min	3h	5h	10h	20h
1.60V	210	153	120	67.5	39.5	16.8	11.7	6.80	3.55
1.65V	200	147	115	65.5	38.3	16.6	11.5	6.70	3.50
1.70V	188	140	109	62.8	36.8	16.3	11.3	6.60	3.45
1.75V	174	131	103	59.8	35.0	16.0	11.1	6.50	3.40
1.80V	161	119	95.7	56.1	32.9	15.6	10.9	6.40	3.35

Constant Power Discharge (Watts/cell) at 25°C(77°F)

E.V/Time	5min	10min	15min	30min	45min	60min	2h	3h	5h
1.60V	350	233	183	122	96.7	76.7	49.8	34.4	23.0
1.65V	328	220	173	116	92.2	73.4	48.3	33.6	22.6
1.70V	307	206	163	109	87.6	70.1	46.7	32.6	22.1
1.75V	285	193	153	103	82.9	66.6	44.8	31.7	21.7
1.80V	264	179	143	96.6	78.1	63.0	42.9	30.6	21.1

Note: The above characteristics data are average values obtained Within three charge/discharge cycles not the minimum.



Solar GEL Deep Cycle Battery

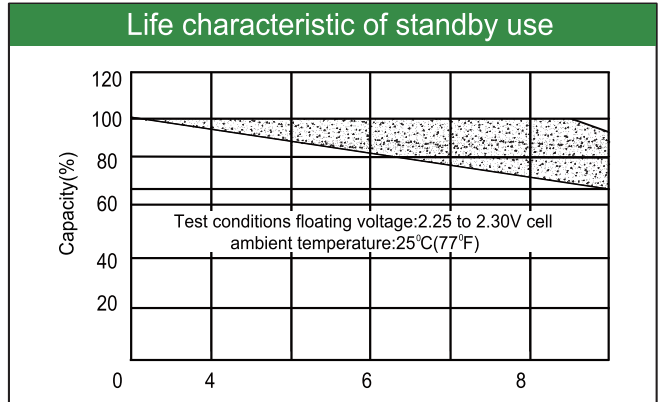
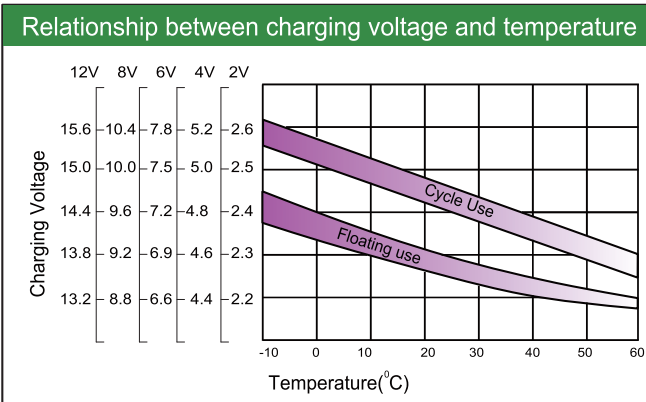
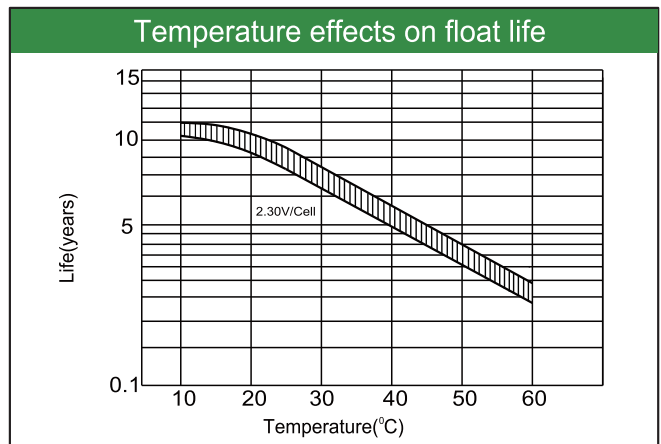
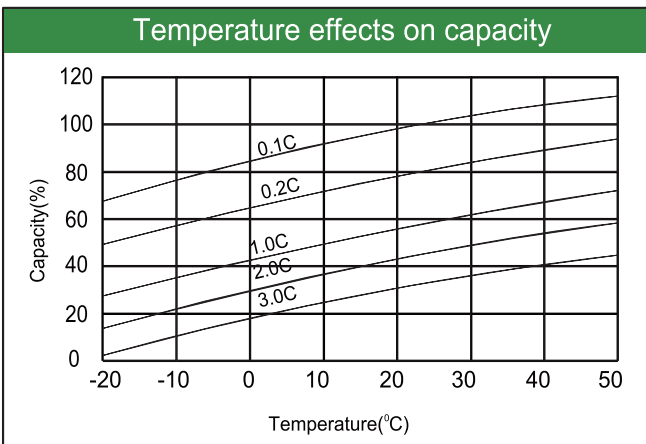
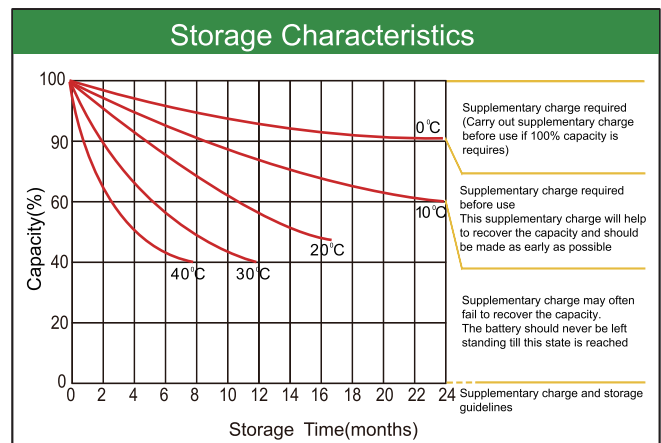
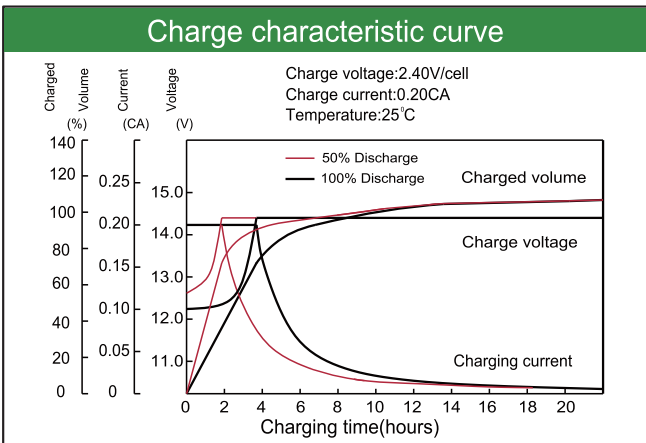
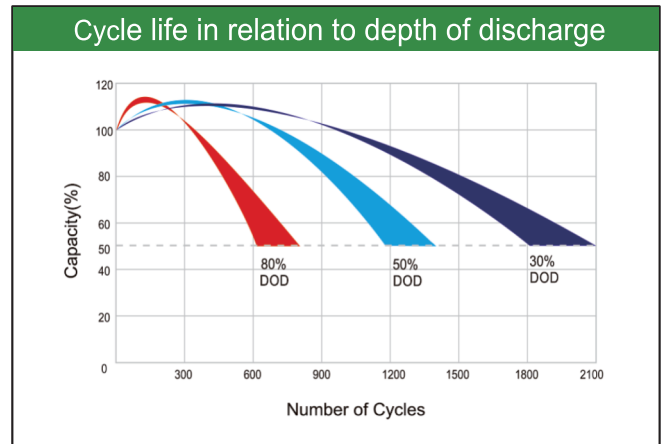
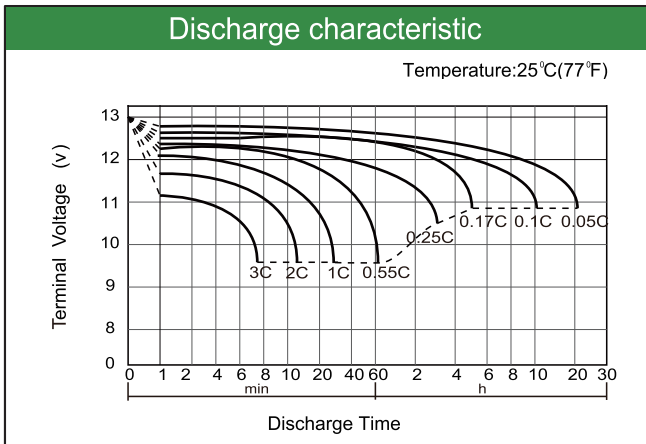

Factory Address: Fukang industrial park, LongNan, GanZhou JianXi.
 Office add: RM208-210, Building D, Tongju industrial Park, No.4, Longping West Road, Longgang District, Shenzhen.
 TEL: +86-755-28288189 sales@sfbattery.com www.sfbattery.com